



50471/\*\*/\*\*

50472/\*\*/P7

50473/\*\*/P7

50474/\*\*/P7

Gebruiksaanwijzing

Notice d'emploi

Benutzerhandbuch

User manual

Manual de usuario

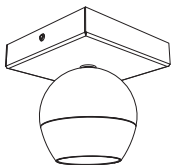

50471/\*\*/\*\*

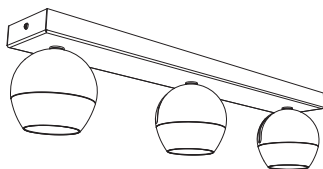

50473/\*\*/P7

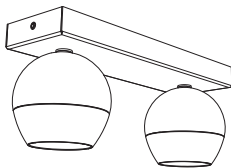

50472/\*\*/P7

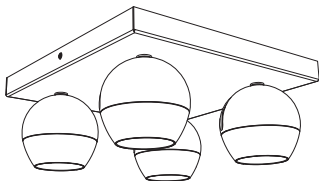

50474/\*\*/P7

# PHILIPS

Incl.

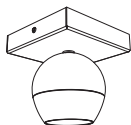

50471/\*\*/\*\*

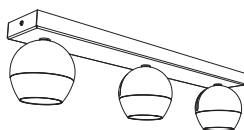

50473/\*\*/P7

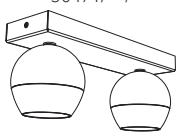

50472/\*\*/P7

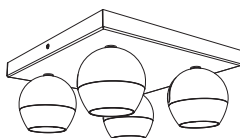

50474/\*\*/P7

Excl.

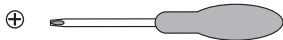
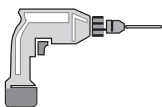

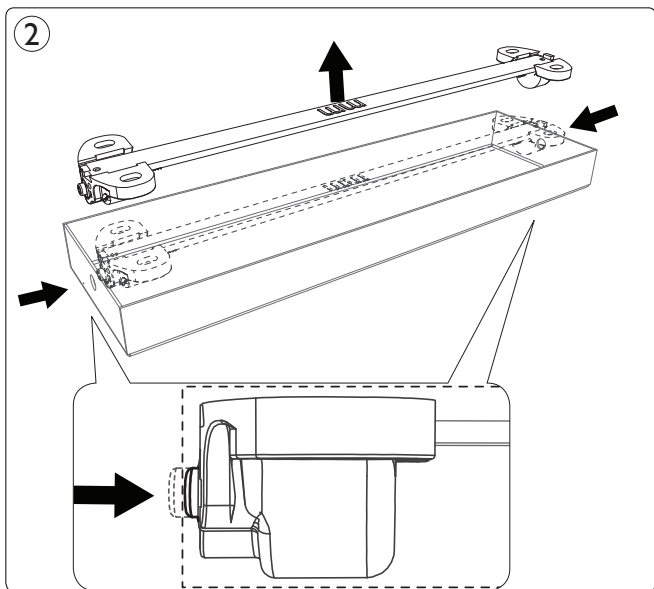
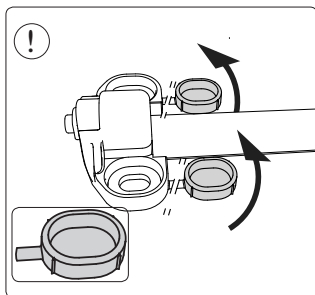
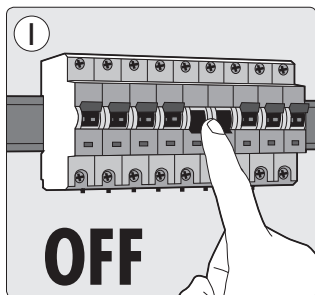

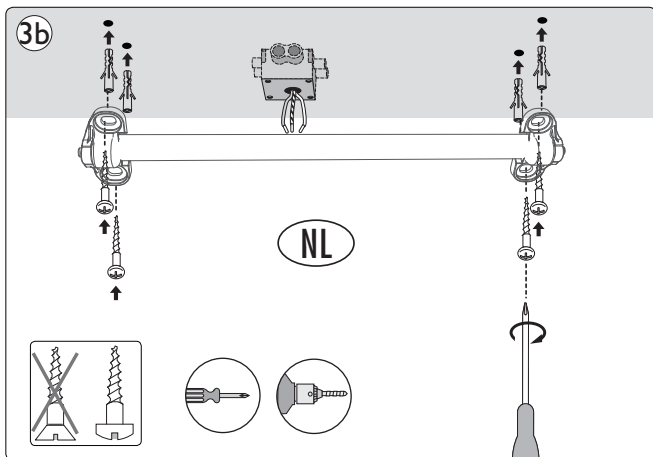
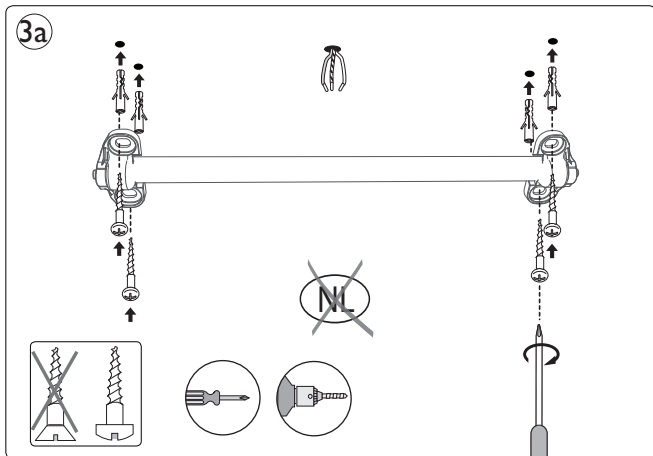

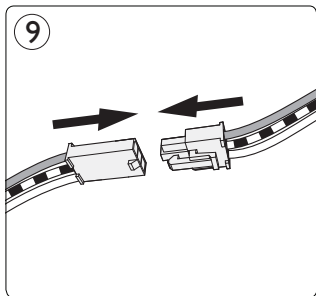
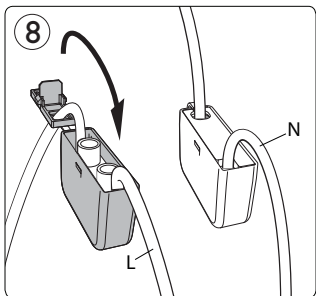
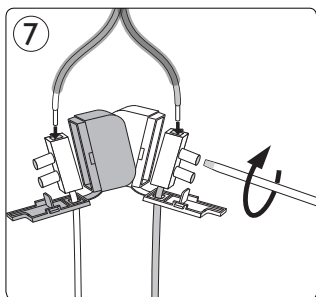
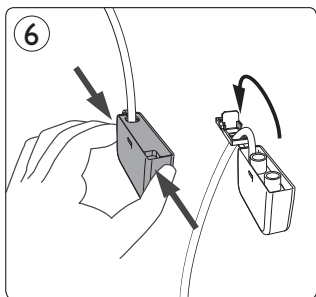
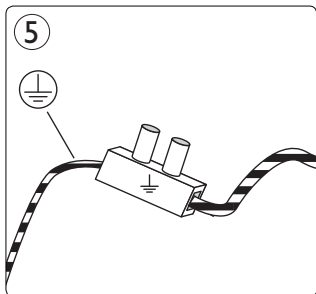
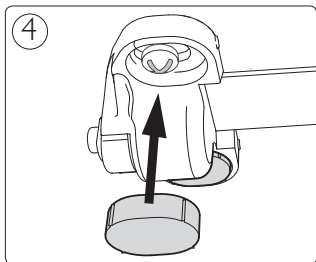

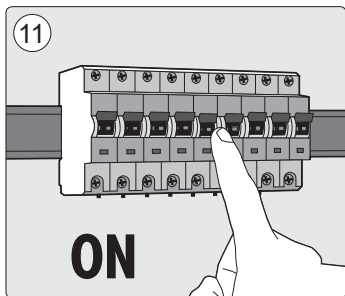
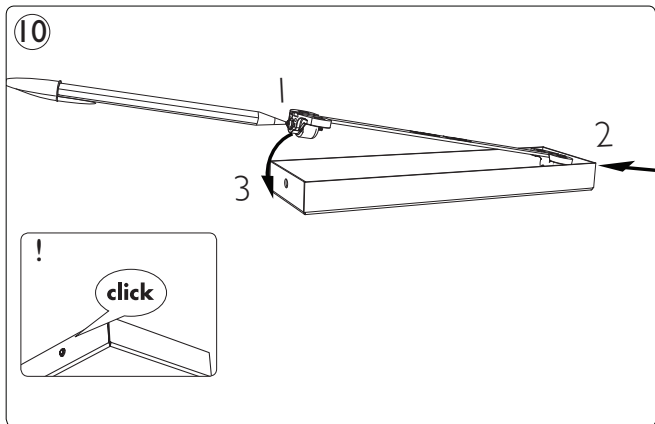

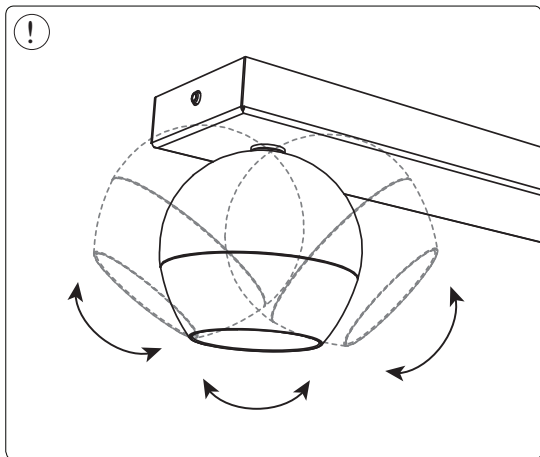



Philips Lighting Contact Centre  
Int. Business Reply Service  
I.B.R.S. / C.C.R.I. Numéro 10461  
5600 VB Eindhoven  
Pays-Bas / The Netherlands

[www.meethue.com/getstarted](http://www.meethue.com/getstarted)  
[www.philips.com/homelighting](http://www.philips.com/homelighting)  
☎ +800 7445 4775

4404.029.07731  
Last update: 26/06/18